

BUMPER MOUNTED TIRE CARRIER

21 + JEEP WRANGLER JL

TCJL-13



TOOLS REQUIRED

- T8, T25 Torx Bit
- #4, #5 Allen Head Bit
- 13, 17, 18, 19mm Wrenches
- 13, 17, 18mm Socket
- 30mm Socket
- Safety Glasses
- Dremel/ Cutting Tool
- File
- Rubber Mallet
- Trim Clip Tool

SKILL LEVEL

- Novice/Intermediate
- 1 (you) to 2 persons

Little skill level required, you can easily install it by yourself however, additional help will be useful

TIME REQUIRED

- 1 Hour

Time to install this should only take about an hour

WARNINGS/CAUTIONS BEFORE STARTING INSTALLATION

Before you install this kit – Read and understand all instructions, warnings, cautions, and notes contained in this installation instruction guide. Consult your vehicle owner's manual for proper disconnection of electrical and lifting of vehicle if required for installation of this product.

This install may require some technical skills and knowledge of basic mechanical work. If you do not feel that you are capable of performing this install please take this product to a trained professional.

After reading this guide please contact us with any questions or concerns before installing product.
Customer Service: 855-680-9595

DV8 Offroad is not responsible for any bodily injury or harm to you or your vehicle as a result of an improper install.

Proper installation of this kit required knowledge of the factory recommended procedures for removal and installation of original equipment components. We recommend that the factory shop manual and any special tools needed to service your vehicle be on hand during the installation. Installation of this kit without proper knowledge of the factory recommended procedures may affect the performance of these components and the safety of the vehicle

- Always wear eye protection when operating power tools

Inspect all contents of this package to make sure product is not damaged and all installation hardware has been included. If parts are missing from kit, please be prepared to provide the following information

1. Name of purchase location
2. Bar Code on side of box
3. Date above bar code
4. Date inside box cover



INSTALLATION MANUAL

Begin by unpacking all items and inspecting for missing pieces or damage. If you have any concerns, please contact the company the product was purchased from. Extra hardware may be included with the product.

HARDWARE INCLUDED

- | | |
|------------------------|-----------------------------------|
| (2) M10x25mm Bolts | (3) M10x30 Countersunk bolts |
| (2) M10 Nuts | (3) M10 Nuts |
| (2) M10 Split Washer | (3) M10 Flat Washers |
| (4) M10 Flat Washers | (3) split Washers |
| (4) M12x50mm Bolts | (1) M6x14 Allen head Bolt |
| (10) M12 Split Washers | (1) M6 split Washers |
| (20) M12 Flat Washers | (1) M6 Flat Washers |
| (10) M12 Nuts | (2) M12x40 Connect Nuts |
| (6) M12x35 Hex Bolts | (2) M12 Nuts |
| (2) M8x45 Hex Bolts | (2) M12 Hex Nuts (Reverse Thread) |
| (4) M8 Washers | (3) Lug Nuts |
| (2) M8 Split Washers | |
| (2) M8 Nuts | |

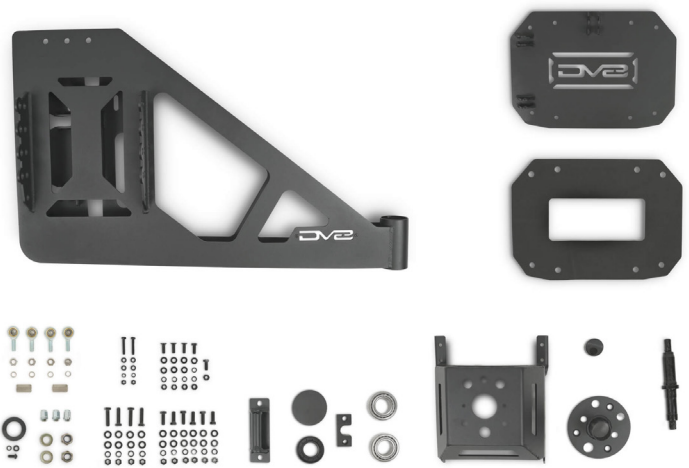

STEP 1 | Remove the spare tire if you have one installed.

Use a 13mm socket to remove the bottom (6) bolts from the factory spare tire carrier.



STEP 2 | Use a T25 torx bit to remove the hardware securing the third brake light to the tire carrier.



INSTALLATION MANUAL

STEP 3 | Loosen the remaining hardware on the passenger side and remove the hardware on the passenger side, allowing the tire carrier to drop and rotate slightly to the passenger side.

Remove the third brake light and gently set it on the bumper.

Use a zip tie to secure it to the tailgate handle to ensure it does not fall, or pull on the wiring.



INSTALLATION MANUAL

STEP 4 | Use a T25 torx bit to remove the two bolts securing the stud plate to the tire carrier.

Then, using a rubber mallet, remove the stud plate.

Use the mallet with caution, taking care not to damage the carrier or vehicle paint.



INSTALLATION MANUAL

STEP 5 | Remove the factory carrier and set it off the side.



STEP 6 | Open the tailgate and use a trim clip tool to remove the plastic panel from the tail gate.

Clips are located along each edge.

Pull straight away from the tailgate to avoid breaking any clips.

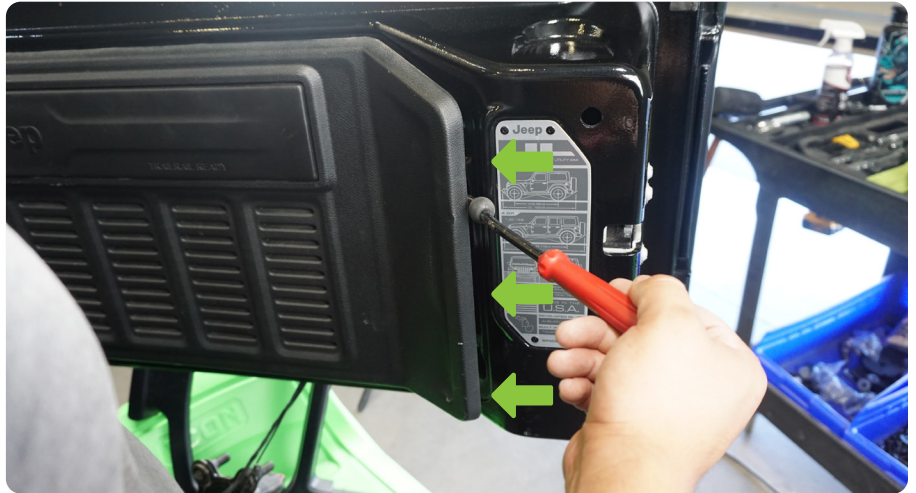

INSTALLATION MANUAL

STEP 7 | Remove the fin vents by pulling from the exterior, while using a trim clip tool on the interior if necessary.



STEP 8 | Using a dremmel or cutting tool of choice, remove the three sided border from the fin vents.

Then use a file to clean up any rough edges.



INSTALLATION MANUAL

STEP 9 | Use a T8 torx bit to remove the camera from the factory carrier and disconnect it by pressing the release tab on the connector.

Place the camera off to the side on a soft surface being careful not to scratch/damage it.



INSTALLATION MANUAL

STEP 10 | Install the heim joints onto the carrier using the provided M12x50 hex bolts with hardware and provided isolators.

Use a 17mm socket and 18mm wrench.

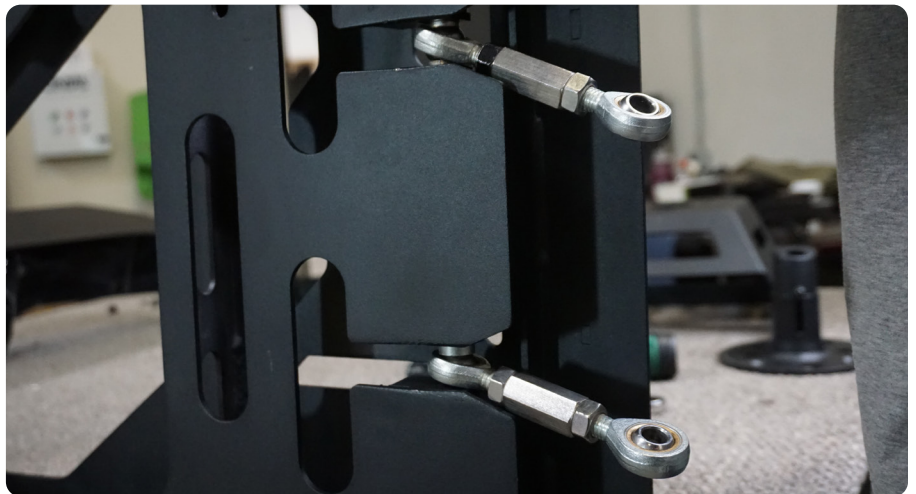
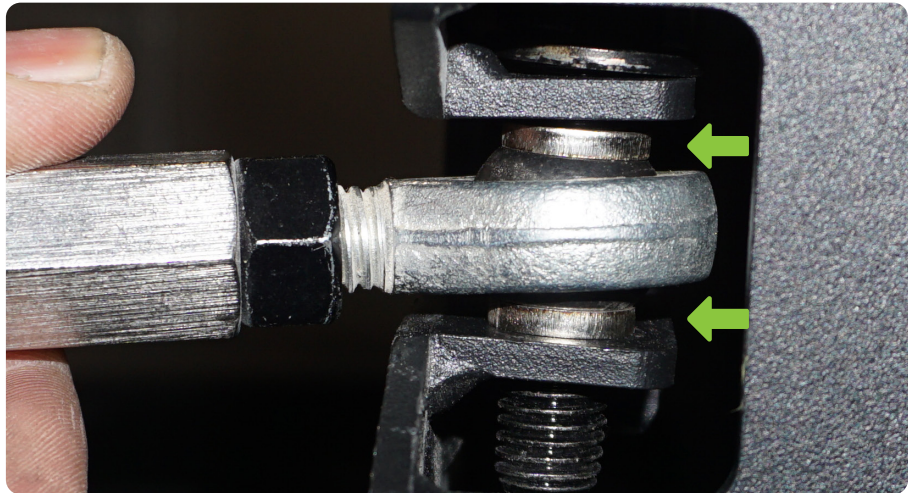

INSTALLATION MANUAL

STEP 11 | Loosely install the stopper bracket using the provided M10x25 hardware.

Use a 18mm wrench and 17mm socket.



STEP 12 | Install the carrier "catch" using the provided M8x45 hardware.

Use a 13mm wrench and socket.



INSTALLATION MANUAL

STEP 13 | Install the backing plate to the tailgate of the vehicle using the factory hardware and a 13mm socket.



STEP 14 | Install the provided spacer plate, followed by the bearing as shown.



INSTALLATION MANUAL

STEP 15 | Place the carrier post over the stud/bearing and ensure it is seated properly over the spacer plate.



STEP 16 | Then install the race and remaining bearing as shown with the race being placed first, and the bearing on top, facing down.



STEP 17 | Place the provided M30 washer and loosely thread the nut into place.



INSTALLATION MANUAL

STEP 18 | Using a 30mm socket and provided hardware, secure the tire carrier to the main support post.

Be careful not to overtighten the nut, as this can lead to premature failure of the bearing.



STEP 19 | Install the dust cap.



INSTALLATION MANUAL

STEP 20 | Feed the rear back up camera wiring harness through the DV8 Tire Carrier.



INSTALLATION MANUAL

STEP 21 | Using the factory camera housing previously removed, feed the rear camera wiring harness through the rear camera housing.



STEP 22 | Reconnect the rear camera harness to the rear camera.

Reinstall the rear camera on to the factory camera housing using factory hardware and a T8 Torx bit.



INSTALLATION MANUAL

STEP 23 | Using the provided M12x35 hardware, 18mm socket and 19mm wrench, secure the tire carrier to the swing arm.

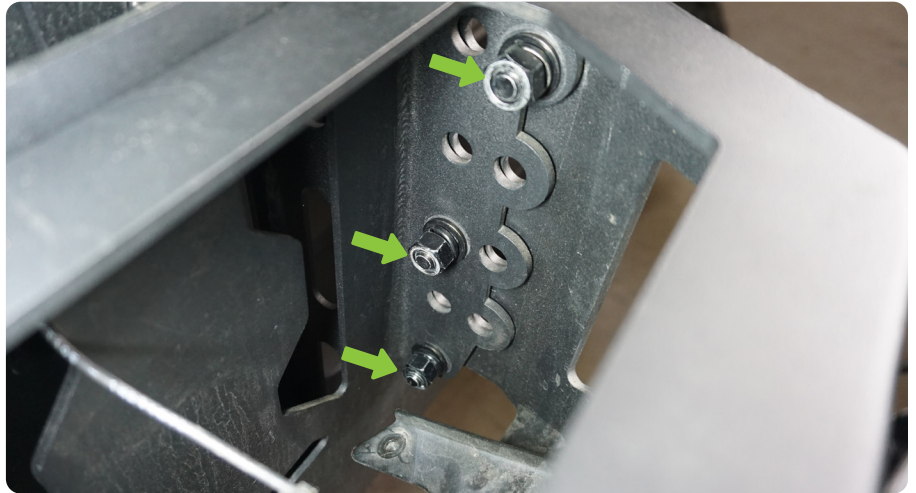

INSTALLATION MANUAL

STEP 24 | Feed factory tire mount and rear camera through DV8 Tire Carrier.



STEP 25 | Secure the factory rear camera/ tire mount to the DV8 Tire Carrier using the (2) factory torx head screws previously removed.

Use a T25 torx bit.



INSTALLATION MANUAL

STEP 26 | Secure the factory Rear brake light onto the DV8 Tire Carrier using the (4) factory torx head screws previously removed.

Reconnect the rear brake light to factory wiring harness.



INSTALLATION MANUAL

STEP 27 | Secure the DV8 stud plate on to the DV8 Tire Carrier using the provided M10 countersunk allen head bolts and hardware with a #6 Allen bit and 17mm wrench.



STEP 28 | Adjust the camera tube and secure using the provided M6 hardware with a #4 allen bit.



INSTALLATION MANUAL

STEP 29 | Secure the heim joint to the DV8 Back Plate using the provided M12 hardware, an 18mm wrench and an 18mm socket.

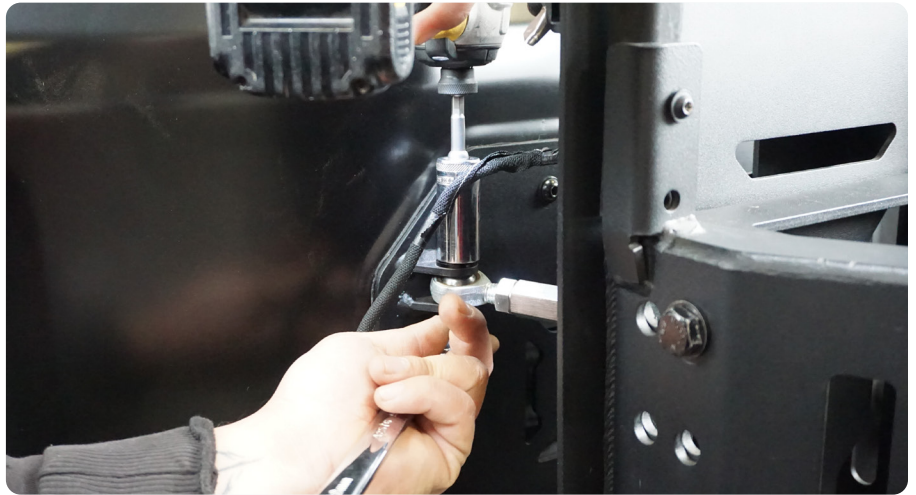

STEP 30 | Adjust the heim joints by turning the center connector nut.

This is adjusted properly when the tail gate is closed the swing arm is parallel with the tail gate and the carrier stopper lands in the catch.



STEP 31 | Check and adjust the tire catch up/down so that the stopper lands in it when the tailgate is closed.

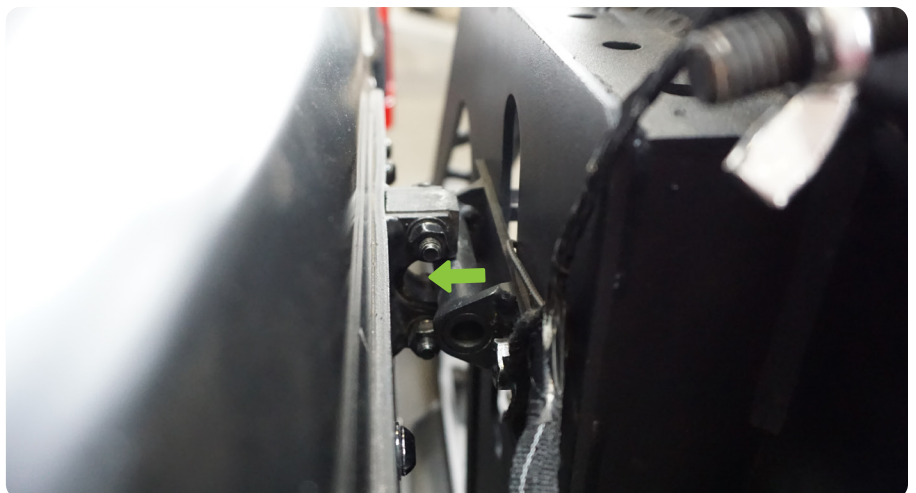

INSTALLATION MANUAL

STEP 32 | Double check that all hardware is secure.

Congratulations, The DV8 Bumper Mounted Tire Carrier installation is now complete.

