

BED RACK

UNIVERSAL

RRUN-03



TOOLS REQUIRED

- 6mm Allen head & 13mm sockets
- 17mm wrench
- Safety Glasses

SKILL LEVEL

- Novice/Intermediate
- 1 (you) to 2 persons

Little skill level required, you can easily install it by yourself however, additional help will be useful

TIME REQUIRED

- 2 Hours

Time to install this should only take about two hours

WARNINGS/CAUTIONS BEFORE STARTING INSTALLATION

Before you install this kit – Read and understand all instructions, warnings, cautions, and notes contained in this installation instruction guide. Consult your vehicle owner’s manual for proper disconnection of electrical and lifting of vehicle if required for installation of this product.

This install may require some technical skills and knowledge of basic mechanical work. If you do not feel that you are capable of performing this install please take this product to a trained professional.

After reading this guide please contact us with any questions or concerns before installing product.
Customer Service: 855-680-9595

DV8 Offroad is not responsible for any bodily injury or harm to you or your vehicle as a result of an improper install.

Proper installation of this kit required knowledge of the factory recommended procedures for removal and installation of original equipment components. We recommend that the factory shop manual and any special tools needed to service your vehicle be on hand during the installation. Installation of this kit without proper knowledge of the factory recommended procedures may affect the performance of these components and the safety of the vehicle

- Always wear eye protection when operating power tools

Inspect all contents of this package to make sure product is not damaged and all installation hardware has been included. If parts are missing from kit, please be prepared to provide the following information

1. Name of purchase location
2. Bar Code on side of box
3. Date above bar code
4. Date inside box cover



INSTALLATION MANUAL

Begin by unpacking all items and inspecting for missing pieces or damage. If you have any concerns, please contact the company the product was purchased from. Extra hardware may be included with the product.

HARDWARE INCLUDED

- | | |
|-----------------------|----------------------|
| (32) M10x30mm Bolts | (12) M8 Lock Washers |
| (32) M10 Lock Nuts | (12) M8 Flat Washers |
| (64) M10 Flat Washers | (12) M8 Nuts |
| (4) M8 Serrated Nuts | |
| (4) M8x16mm Bolts | |

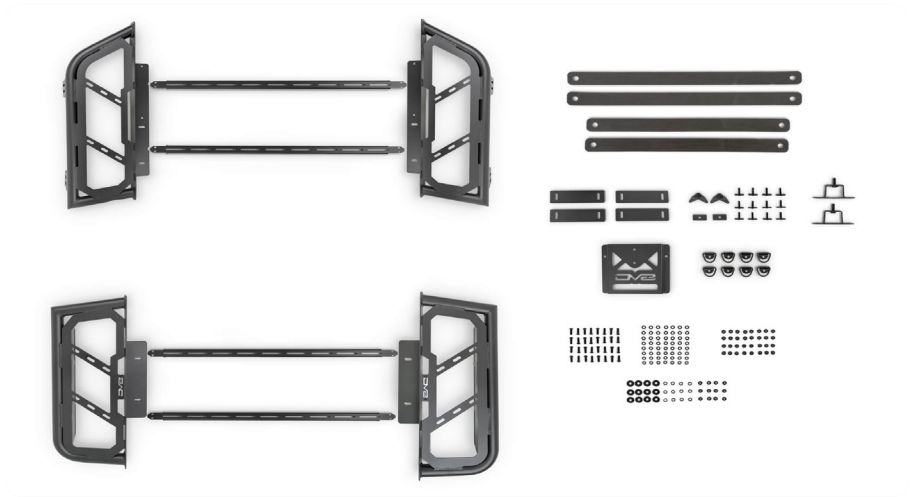

STEP 1 | Bed Rail equipped trucks:

Remove all bed rail cleats.

If the vehicle is not equipped with bed rails, skip to step 5.



STEP 2 | Twist counter clockwise and pull cleat out of bed rail.

Removal may vary depending on bed rail cleat type.



INSTALLATION MANUAL

STEP 3 | Remove bed rail end caps, depress lined tabs and slide end caps out of bed rails.

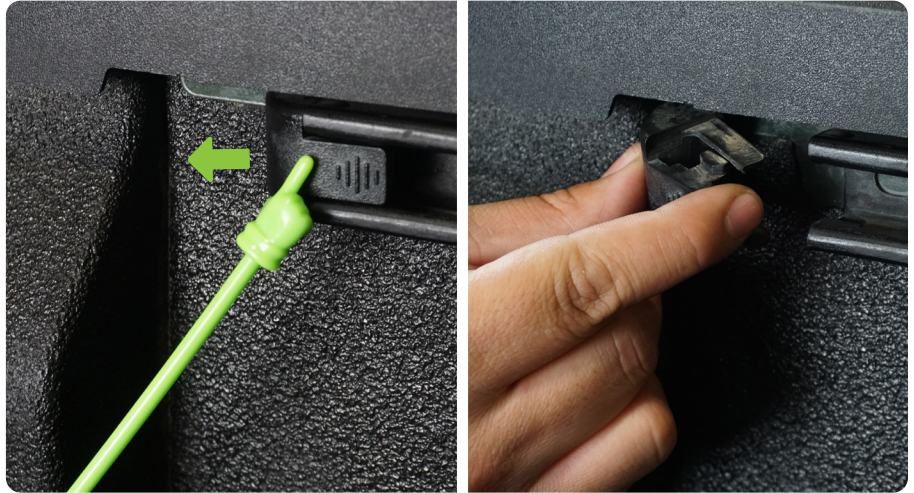

STEP 4 | Slide (4) T-bolts into each bed rail.

Slight pressure may be needed to slide T-bolts into place.

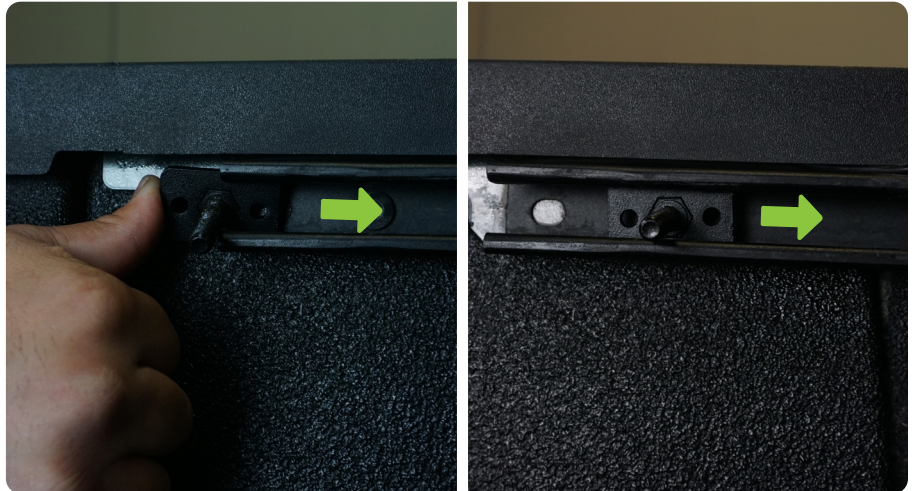

INSTALLATION MANUAL

STEP 5 | Assemble the provided bedside assemblies and crossbars using a 17mm wrench, #6 Allen bit and provided M10 hardware.

Leave loose enough to allow for adjustment.

Pair up matching bed sides.

Front Bed-Rack Section



Rear Bed-Rack Section

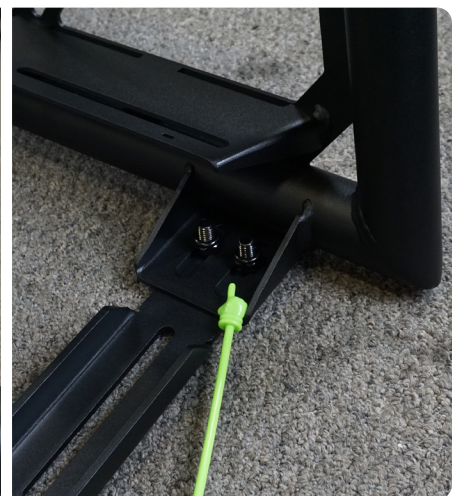

INSTALLATION MANUAL

STEP 6 | Place the provide foam strips onto each of the (4) bedside sections.

These are specific to front and rear mounts.



STEP 7 |

If equipped with bed rails:

Place both front and rear sections of the bed rack over the T-bolts, secure bed-rack to T-bolts using 13mm socket and provided M8 hardware.

If not equipped with bed rails:

Slide the provided bedside mounting plate behind the bed-rail lip.

Secure the bed rack and mounting plate to the bed-rail using a 17mm wrench, #6 allen bit and provided M10 Hardware.

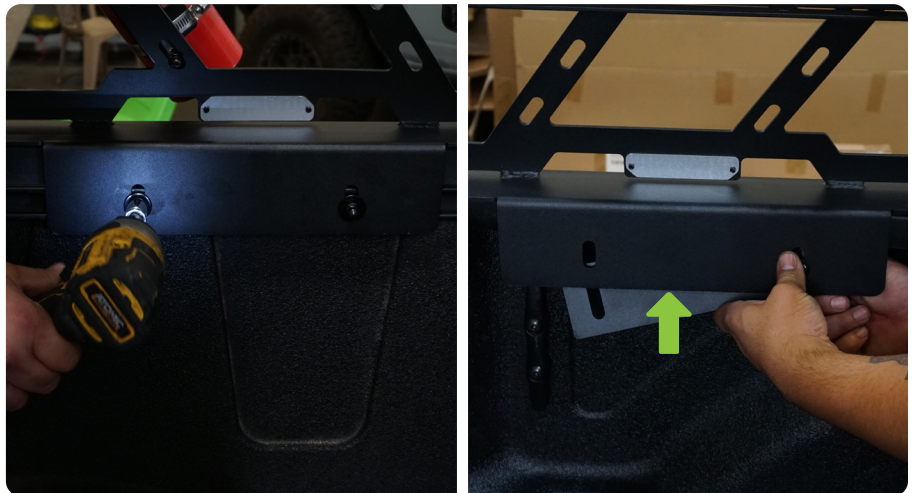

INSTALLATION MANUAL

STEP 8 | Adjust the positioning and spacing of each rack prior to fully securing the hardware.

For proper installation the top of the racks should be angled slightly towards each other.

Proper installation is critical to the strength of the rack.

When positioned properly, secure all M10 hardware securing the cross bars to the assembly and assemblies to the bed of the vehicle.



STEP 9 | Included are optional Rotopax mounts.

If you are installing a Rotopax can, install the Rotopax mount onto the DV8 mounting bracket.

(Rotopax not included)

If you are not installing a Rotopax mount, skip to step 10.

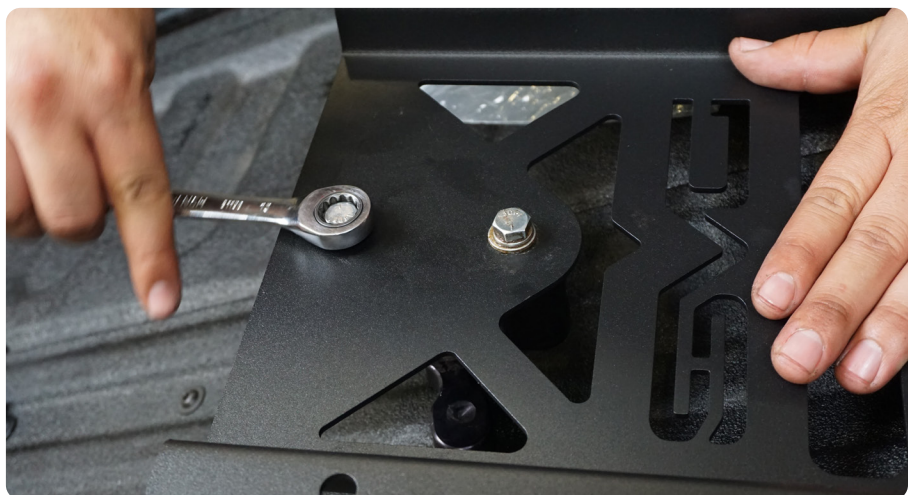

INSTALLATION MANUAL

STEP 10 | These mounts can be installed with or without cargo-rings in place.

Secure the DV8 mount to the bedrack using a 13mm wrench and provided M8 hardware.

Then, install the Rotopax can to the Rotopax mount.



STEP 11 | Optional high lift jack mounts are included in our kit.

High lift mounts can be installed on either driver or passenger side of the bed rack.

Secure each mount to front and rear bed sides using provided M10 hardware, 17mm wrench and #6 Allen bit.

If not installing a high lift jack, skip to step 12.



STEP 12 | Use provided mounting plate and nut plate to secure high lift jack to bed rack.

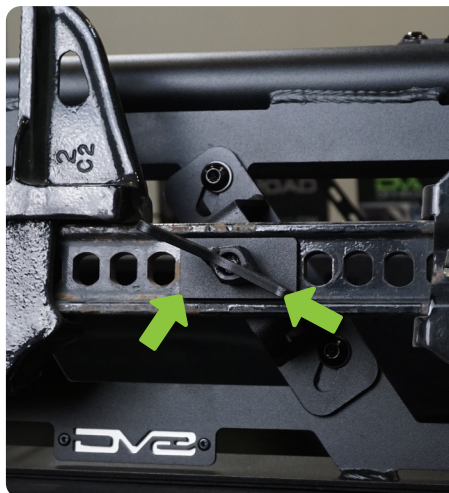

INSTALLATION MANUAL

STEP 13 | If you are installing lights in the rail, do so now using the hardware provide with the lights.

The design of the rail allows for many configurations of light mounting.

If you are not mounting lights, skip to step 13.



STEP 14 | If you are installing a RTT, do so now using the hardware provided with the tent.

If you are not mounting a RTT skip to step 14.

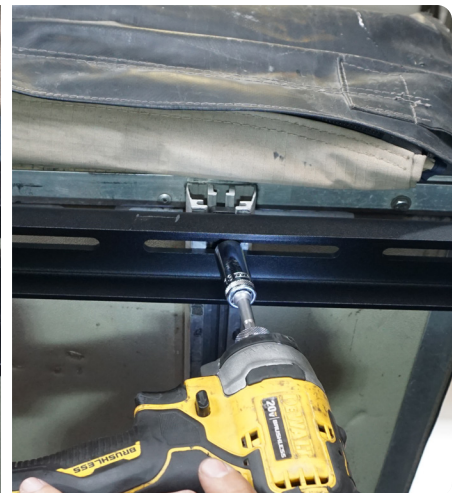

INSTALLATION MANUAL

STEP 15 | If installing any other accessories do so now.

Double check fitment and all hardware is secure.



STEP 16 |

Congratulations, the Bed Rack install is now complete.

